



LED CANLESS SPOTLIGHT
REGRESSED INTERCHANGEABLE TRIM
CCT SELECTABLE
2" MODULE

2" MODULE



*TRIMS SOLD SEPARATELY



LR25020



LR25021

INTERCHANGEABLE TRIMS
*SOLD SEPARATELY

LR25 022



LR25 024



LR25 025



LR25 026



LR25 027



LR25 028



LR25 032

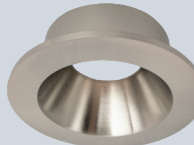

LR25 033

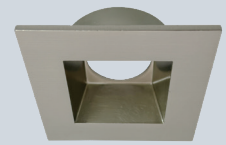

LR24921



LR24922



CRI 90

COLOR SELECTABLE

2700K 3000K 3500K 4000K 5000K

HIGH OUTPUT

DIMMABLE TRIAC

AIR TIGHT

IC RATED

WET LOCATION RATED

120V

5 YEAR WARRANTY

ELECTRICAL

	MODEL	DESCRIPTION	POWER	LUMENS	EFFICACY	INPUT VOLTS	DIMMABLE	LIFETIME	COST/YR
2"	38° LR25020	LED/DLMD2HO/5CCT/D/FL	15	1000	66	120V	TRIAC	50,000	\$ 1.80
	60° LR25021	LED/DLMD2HO/5CCT/D/WFL	15	1000	66	120V	TRIAC	50,000	\$ 1.80

PHOTOMETRIC

MODEL	DESCRIPTION	COLOR (CCT)	TEMP	FLOOD°	CRI	ETL	PLATE (KNOCKOUT)
LR25020	LED/DLMD2HO/5CCT/D/FL	2700K/3000K/3500K /4000K/5000K	CCT SELECT	38°	90	YES	LR41004 (#1) LR41010 (L1)
LR25021	LED/DLMD2HO/5CCT/D/WFL	2700K/3000K/3500K /4000K/5000K	CCT SELECT	60°	90	YES	LR41011 (#1)

COMPATIBLE WITH :

LR35126
Emergency LED Driver



LR41004
New Construction Mounting Plate

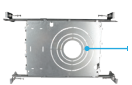

KNOCKOUTS

KNOCKOUT SIZE	
#0	Ø2.125" (Ø54 mm)
#1	Ø2.83" (Ø72 mm)
#2	Ø3.75" (Ø95 mm)
#3	Ø5.19" (Ø132 mm)

LR41010
New Construction Mounting Plate



KNOCKOUTS

KNOCKOUT SIZE	
#L0	Ø2.12" (Ø54 mm)
#L1	Ø2.83" (Ø72 mm)
#L2	Ø3.75" (Ø95 mm)



KNOCKOUTS

KNOCKOUT SIZE	
#R0	Ø3.25" (Ø82 mm)
#R1	Ø4.33" (Ø110 mm)
#R2	Ø5.25" (Ø132 mm)
#R3	Ø6.25" (Ø160 mm)

LR41011
New Construction Mounting Plate



KNOCKOUTS

KNOCKOUT SIZE	
#0	Ø2.48" (Ø63 mm)
#1	Ø2.83" (Ø72 mm)
#2	Ø3.34" (Ø85 mm)
#3	Ø3.74" (Ø95 mm)
#4	Ø4.25" (Ø108 mm)

INTERCHANGEABLE TRIMS

*SOLD SEPARATELY



LR25022



LR25024



LR25025



LR25026



LR25027



LR25028



LR25032

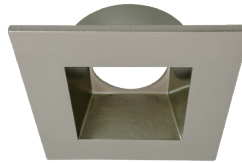

LR25033



LR24921
NARROW TRIM



LR24922
NARROW TRIM

MODEL	DESCRIPTION	DESCRIPTION
LR25022	LED/DLMD2/TRIM/RD/WT	ROUND WHITE TRIM REPLACEMENT
LR25024	LED/DLMD2/TRIM/SQ/WT	SQUARE WHITE TRIM REPLACEMENT
LR25025	LED/DLMD2/TRIM/RD/BK	ROUND BLACK TRIM REPLACEMENT
LR25026	LED/DLMD2/TRIM/SQ/BK	SQUARE BLACK TRIM REPLACEMENT
LR25027	LED/DLMD2/TRIM/RD/BR	ROUND BRASS TRIM REPLACEMENT
LR25028	LED/DLMD2/TRIM/SQ/BR	SQUARE BRASS TRIM REPLACEMENT
LR25032	LED/DLMD2/TRIM/RD/BN	ROUND BRUSHED NICKEL TRIM REPLACEMENT
LR25033	LED/DLMD2/TRIM/SQ/BN	SQUARE BRUSHED NICKEL TRIM REPLACEMENT
LR24921	LED/DLMD2/NTRIM/RD/WT	ROUND WHITE NARROW TRIM REPLACEMENT
LR24922	LED/DLMD2/NTRIM/RD/BK	ROUND BLACK NARROW TRIM REPLACEMENT

2"

2-HEAD RECESSED PLATE

*SOLD SEPARATELY

120-277V DRIVER

*SOLD SEPARATELY



LR23465

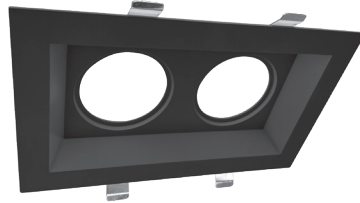

LR23466

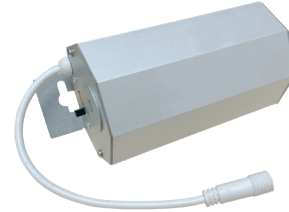

MODEL	DESCRIPTION	FINISH
LR23465	LED/URDL2/RPLT/2HD/WT	WHITE
LR23466	LED/URDL2/RPLT/2HD/BK	BLACK

MODEL	DESCRIPTION	POWER	INPUT
LR23418	LED/URDL2/DRIVER/UNV/0-10V	15	120-277V

DIMENSIONS

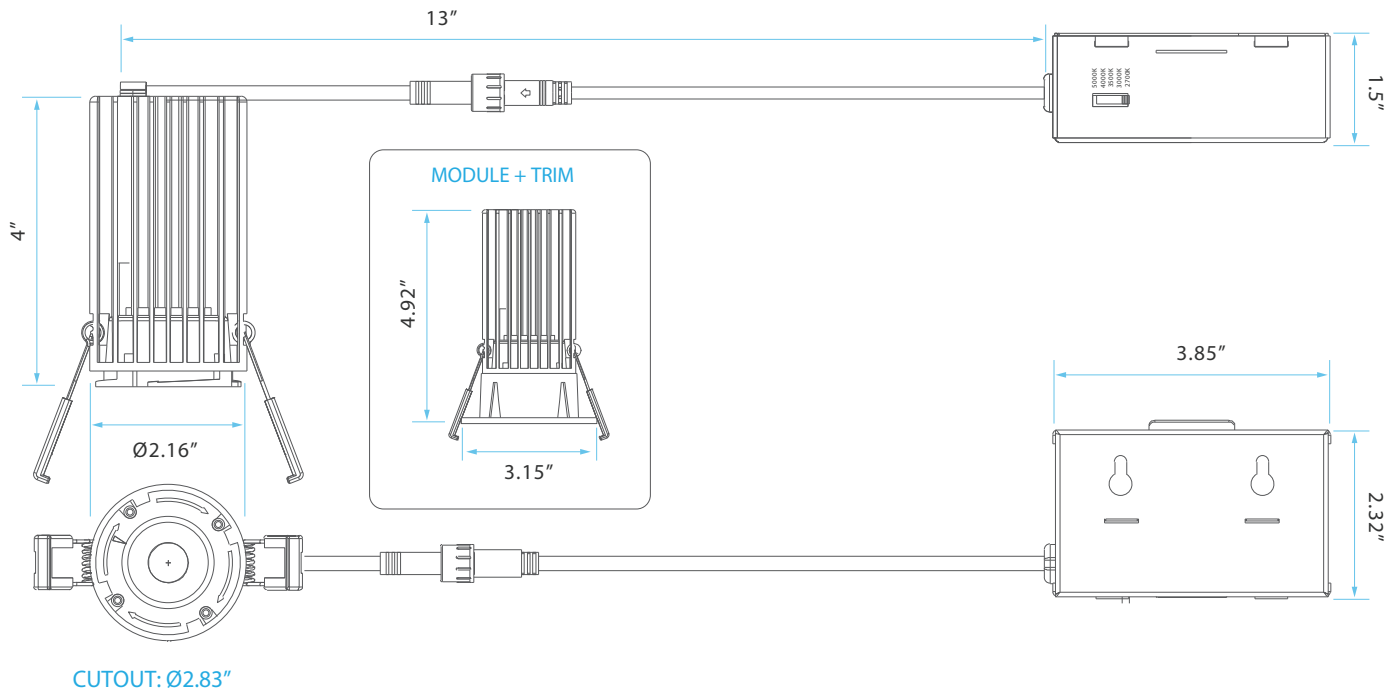

TRIM REPLACEMENT DIMENSIONS

