



LED Linear High Bay – MH5004



Applications: Suitable for factories, warehouses, packaging and distribution centers, manufacturing plants, retail spaces, gymnasiums, and other large areas with high ceilings.

Accessories (Included)	
Image	Description
	Hook
	Chain
	Terminal Cap
	L Shape Connecting Bracket (Optional)
	Microwave Sensor (Optional)

Features

- Ideal Replacement for HID Warehouse Lighting.
- Durable Construction: Die-cast aluminum housing with a white powder-coated finish in a compact, commercial-grade design; impact-resistant acrylic diffusers enhance durability.
- Efficient Performance: Aluminum heatsink ensures optimal heat dissipation; frosted lens minimizes glare.
- Versatile Installation: Lightweight design with multiple mounting options, including chain, pendant, or V hook.
- Optional Features: Infrared induction sensor and emergency backup available.
- Warranty: Backed by a 5-year limited warranty.

Ordering Guide			
Model. No.	MH5004-160W1FT-H-2CCT	MH5004-220W1FT-H-2CCT	MH5004-320W2FT-H-2CCT
Power	100/120/160W	160/190/220W	220/270/320W
Length	1ft	1ft	2ft
CCT	4000K/5000K Selectable		
Input Voltage	AC120-277V		
Dimming	0-10V Dimmable		
Lumens	14000/16800/22400lm	22400/22600/30800lm	30800/37800/44800lm
Protection Rating	IP20 (For Indoor Use Only)		
Power Factor	>0.9		
Beam Angle	110		
CRI	>80		
Working Life	Lumen Maintenance over 70% @ 50,000+ hours		
Oper. Temperature	-4°F ~ +104°F / -20°C ~ +40°C		
DLC #	S-FT329Y	S-T4K7Z3	S-NVFH12

Project Name: _____
Date: _____ Note: _____

LED Linear High Bay – MH5004

Options Ordering Guide

Model NO	MH5004-160W1FT-H-2CCT	MH5004-220W1FT-H-2CCT	MH5004-320W2FT-H-2CCT
Motion Sensor (Max 40ft)	ANT-5-4T/ANT-6-4T/HD09VR-PH-1: ON/Off or Bi-Level and Daylight Harvesting; HD09VR-PHB-1: Bluetooth		
Motion Sensor (Max 50ft)	HD09VR-MH-1: Microwave, ON/Off or Bi-Level and Daylight Harvesting		

Dimensions

Front View

Back View

Side View

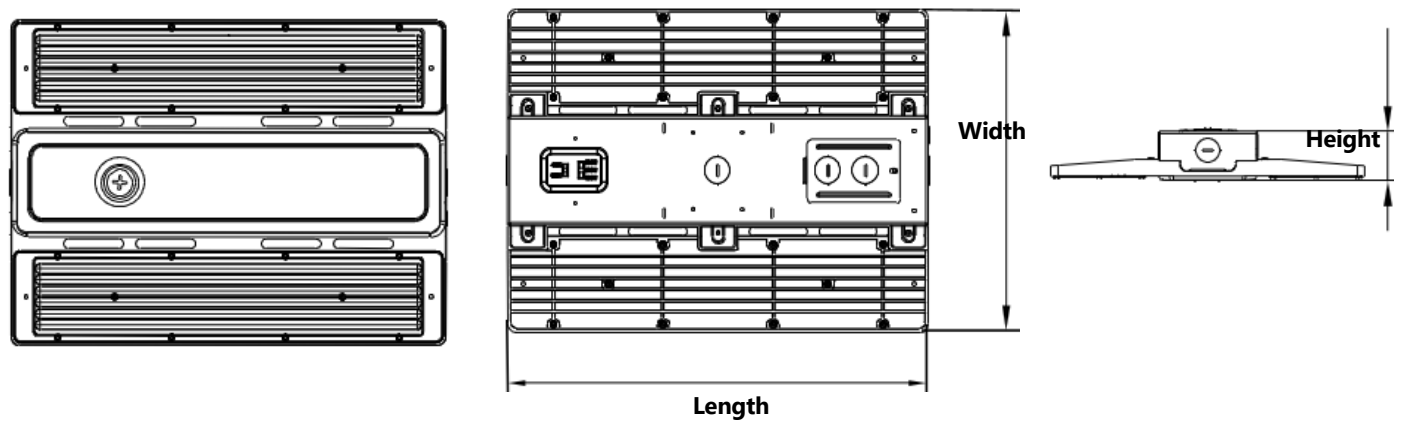

Model NO	Length	Width	Height
MH5004-160W1FT-H-2CCT	14.17in (360mm)	10.63in (270mm)	1.77in (45mm)
MH5004-220W1FT-H-2CCT	18.11in (460mm)	11.30in (287mm)	1.77in (45mm)
MH5004-320W2FT-H-2CCT	23.03in (585mm)	11.30in (287mm)	1.77in (45mm)

LED Linear High Bay – MH5004

Package Info

Model No	HYA-LHB03-160W1FT-H-2CCT	HYA-LHB03-220W1FT-H-2CCT	HYA-LHB03-320W2FT-H-2CCT
Package Size	420X170X343mm 16.53"X7.28"X13.5"	520X170X360mm 20.47"X7.28"X14.17"	645X170X360mm 25.39"X7.28"X14.17"
Package Weight	6.28kg/13.84lbs	8.21kg/18.1lbs	10.17kg/22.42lbs
Qty/Pack	2PCS		
Package CBM	0.02449	0.031824	0.039474
40GP Capacity	~2368PCS	~1822PCS	~1470PCS
40HQ Capacity	~2776PCS	~2137PCS	~1722PCS
45HQ Capacity	~3185PCS	~2450PCS	~1976PCS

Photometric Report

MH5004 -160W1FT-H-2CCT
LUMINOUS INTENSITY DISTRIBUTION DIAGRAM

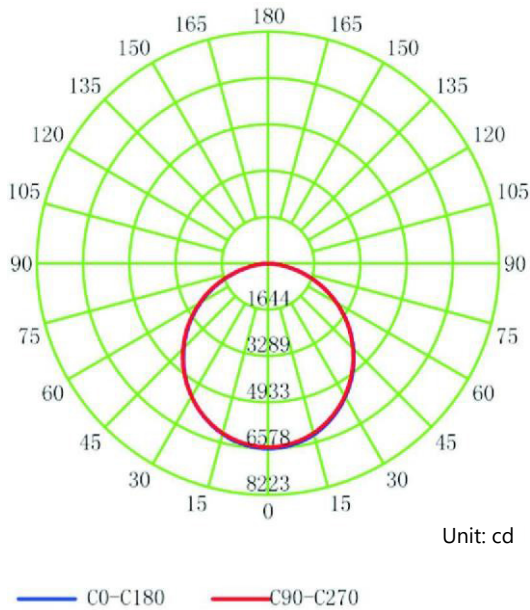

Vertical Equiluminous Curve

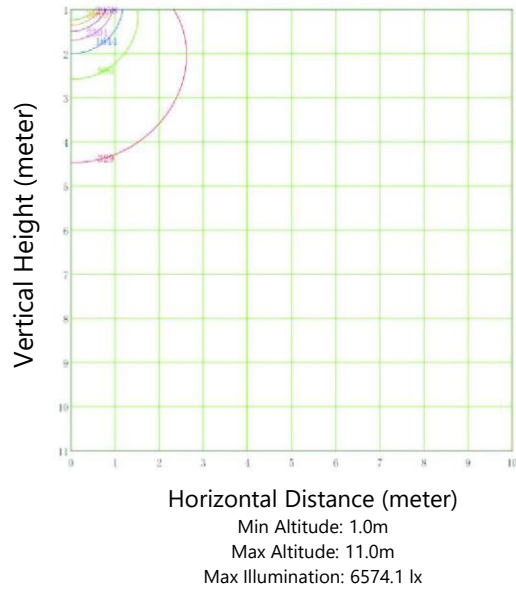

- (5%): 328.7 lx
- (25%): 1643.5 lx
- (45%): 2958.3 lx
- (65%): 4273.2 lx
- (15%): 986.1 lx
- (35%): 2300.9 lx
- (55%): 3615.8 lx

LED Linear High Bay – MH5004

Installation



When using electrical equipment, always follow important basic safety precautions, including the following:

- **Power Off:**
Ensure the power is turned off the circuit breaker or fuse box before installing or servicing this fixture.
- **Avoid Wet Conditions:**
Do not handle the energized module with wet hands, or while standing on wet or damp surfaces, or in water.
- **Indoor Use Only:**
This fixture is not designed for outdoor use.
- **Mounting Precautions:**
Install the equipment at locations and heights that prevent tampering by unauthorized individuals.
- **Approved Accessories Only:**
Use only manufacturer-recommended accessories to avoid unsafe conditions.
- **Intended Use:**
This equipment must only be used for its intended purpose.
- **Installation Codes:**
The product must be installed by the NEC or local electrical codes. If unfamiliar with these codes, consult a qualified electrician.

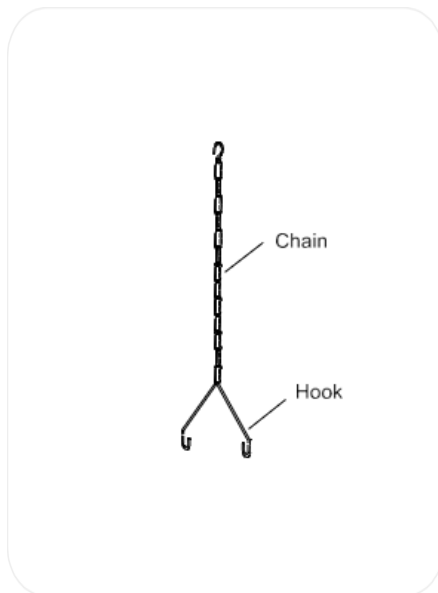

1. Secure the chain as shown in the picture above.



2. Insert the hook into the slotted holes as demonstrated.

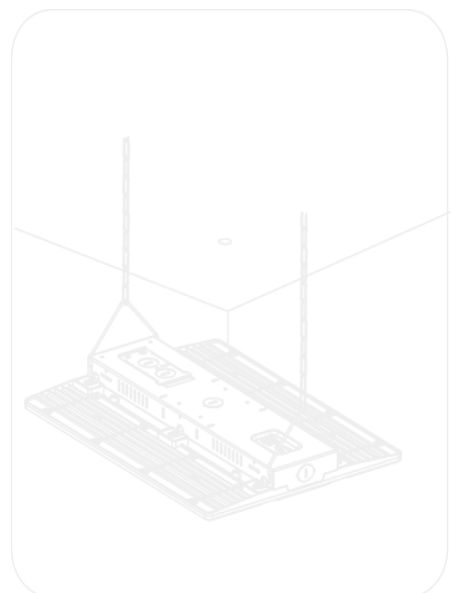

3. Attach the chain to the ceiling anchor.

LED Linear High Bay – MH5004

Installation

Adjust the CCT switch to change the color temperature (4000K-5000K) and use the Watt switch to modify the power settings (220W-270W-320W). Refer to the picture above for guidance.

- 4. Turn off the power and connect the wires using the terminal cap (refer to the picture above).
- 5. Place the terminal cap and wires inside the driver box.
- 6. Insert the wire terminal joint into the wire entry to complete the installation.

Microwave sensor (Provided separately)

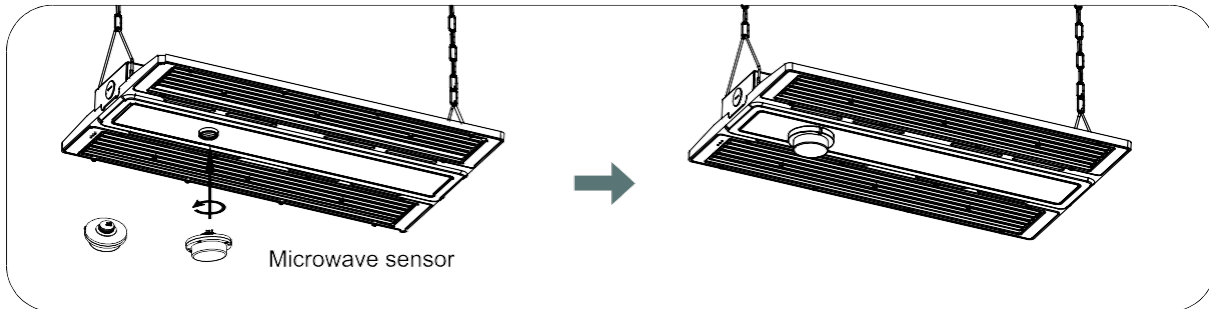

Lamp Body Connecting Bracket (Provided Separately)

Connect the two lights side by side using the connecting brackets.