

LED FRAME LIGHT - PL5007

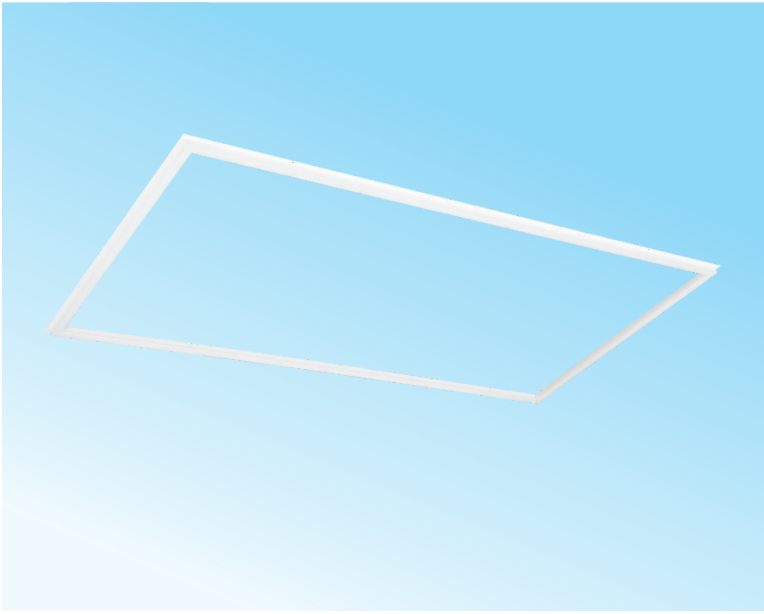

Application: Ideal for office, school, conference room, hospital, and more commercial spaces

Product Description

LED Frame light cast the right light in any commercial setting. The slim profile fixtures are available in 1' x 4', 2' x 2' or 2' x 4' sizes and can save up to 50% of energy usage compared to traditional fluorescent fixtures. Standard 0-10V dimming capability allows greater energy-savings.

Certifications

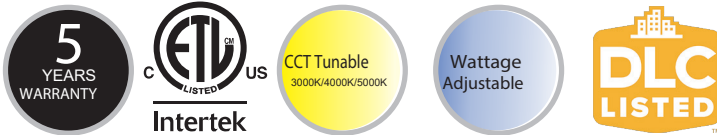

SPECIFICATIONS

| Model No. | HY-PE-1X4P-3W3CCT | HY-PE-2X2P-3W3CCT | HY-PE-2X4P-3W3CCT |
|------------------------|--|-------------------|-------------------|
| Wattage | 20W/30W/40W | 20W/30W/40W | 30W/40W/50W |
| Size | 1x4 | 2x2 | 2x4 |
| Lumens | 5200 LM | 5200 LM | 6500 LM |
| Rated Input Voltage(V) | 120-277 VAC | | |
| Light Source | SMD | | |
| CCT | CCT Selectable: 3000K/4000K/5000K | | |
| Body | White | | |
| Beam Angle (°) | 120° | | |
| Dimming | 0-10V Dimmable | | |
| Lumen Efficiency | 130 Lm/W | | |
| Color Rendering Index | Ra>80 | | |
| Power Factor | 0.95 | | |
| Working Temperature | -4 ° F ~ +105 ° F / -15 ° C ~ +40 ° C | | |
| Storage Temperature | -4 ° F ~ +105 ° F / -15 ° C ~ +40 ° C | | |
| Environment Location | IP 40 – Indoor Only | | |
| Lifespan | Lumen Maintenance over 70% @ 50,000+ Hours | | |
| Warranty | 5 Years Limited | | |
| Certificate | S-1LFS4O | S-IA5BPK | S-ABMCZH |
| Package Info | 49.8"X2.36"X14.2" | 25.8"X2.36"X26" | 49.82"X2.36"X26" |
| PC/ Master Pack | 2 | 2 | 2 |
| Weight | 6.5 lbs | 5.7 lbs | 8.4 lbs |

Feature

- External Driver Box

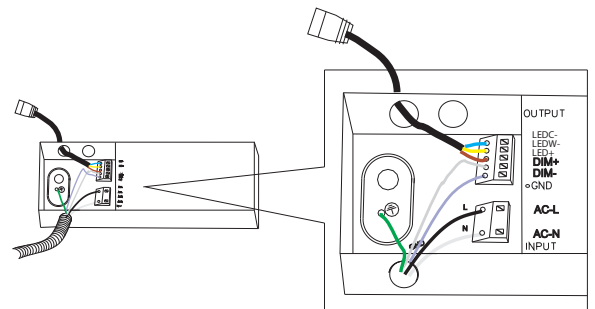

- Watt and CCT Selectable

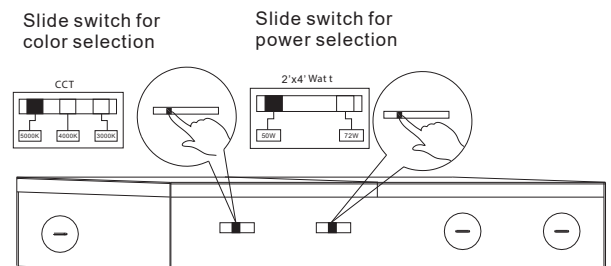

For the product with Slide Switch of CCT or power selection, please select the CCT or power needed before installation. (Ignore these steps if without the function)

ORDERING CODE DEFINITION

EXAMPLE: HY-PE-2X4P-3W3CCT

| Company Code | Product | Size | Power: | CCT |
|---------------|---------------------|------|----------------------------|---------------------------------------|
| PL5007 | PE: LED Frame Light | 1x4P | 3W: | 3CCT Selectable: 3000K/4000K/5000K |
| | | 2x2P | 20W/30W/40W Selectable | |
| | | 2x4P | 3W: 30W/40W/50W Selectable | |

Project Name: _____
Date: _____ **Note:** _____

LED FRAME LIGHT - PL5007

DIMENSION

2x4 Front View

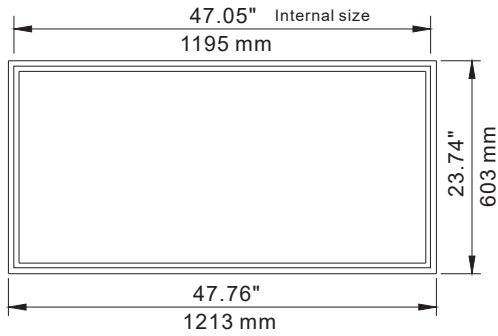

2x2 Front View

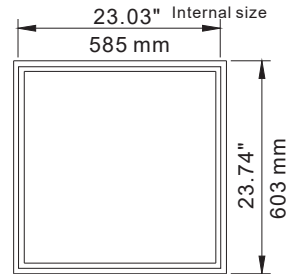

Side View

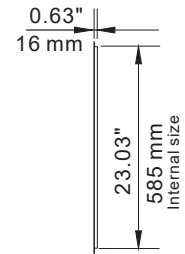

1x4 Front View

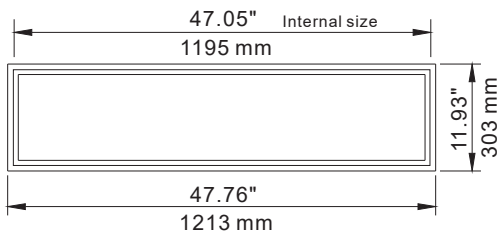

Side View

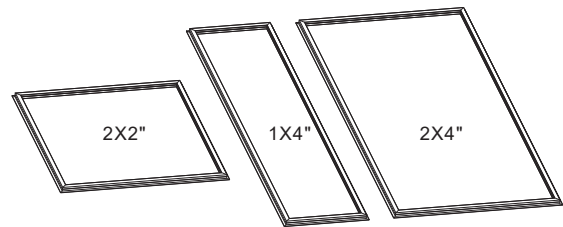
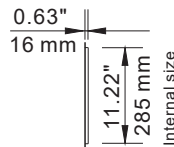

INSTALLATION GUIDE

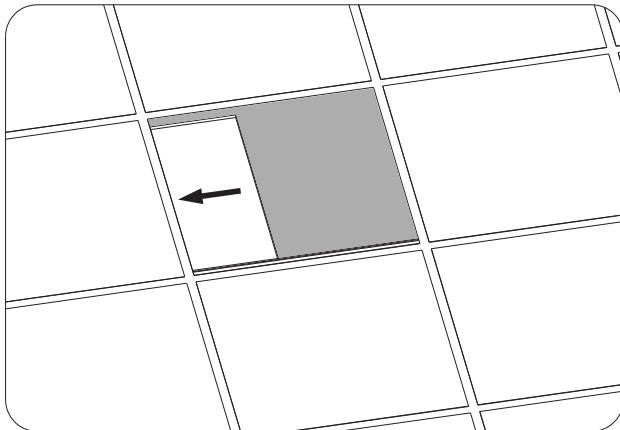

① Remove the ceiling plaster slab.

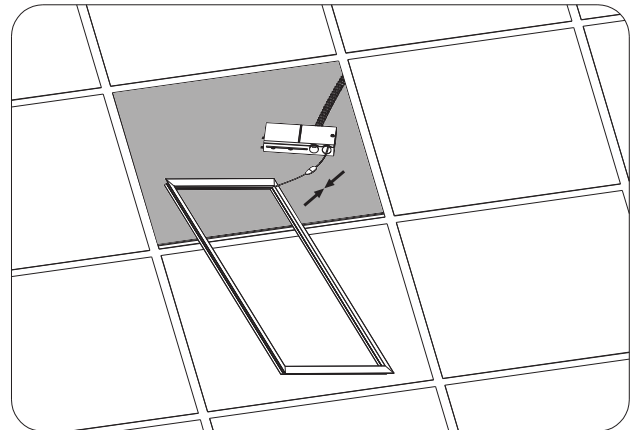

② Feed the main AC wire in driver terminal block respectively, connect the LED Frame light and driver. (see operation guide)

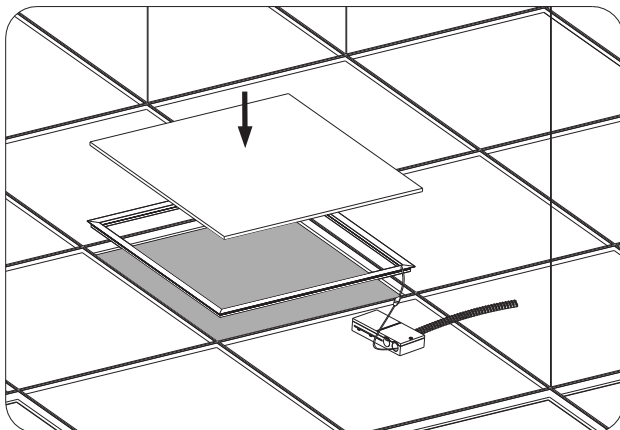

③ Fix the LED Frame light into lightgauge steel joist, cover the ceiling plaster slab.

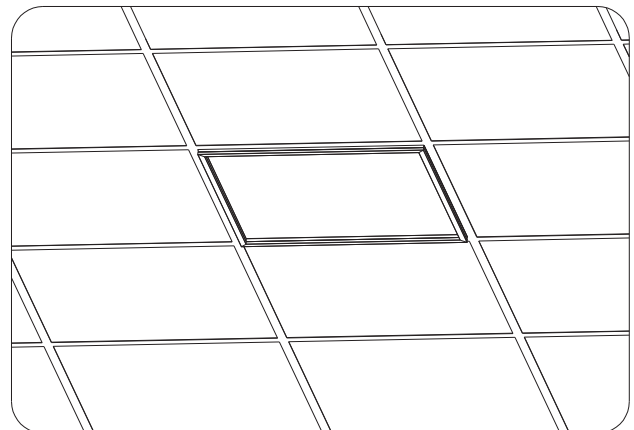

④ Make sure the LED Frame light is firmly fixed, turn on the power.