

## LEDWall PackLight – WP Series WP2002



**Application:** Ideal for outdoor use as non-cutoff and semi-cutoff wall-mounted area luminaires. Suitable for site lighting, entrances, security lighting, perimeters, and various other outdoor wall-mount applications.

### Features

- Isolated, 0-10V dimmable driver.
- Die-cast aluminum housing delivers bright, uniform light.
- Lumen Maintenance over 70% @ 50,000+ Hours.
- Efficient alternative to HID lighting, providing significant energy savings.
- cULus wet location rated with an easy-to-access wiring compartment.
- Impact-resistant and durable glass lens.

### Specification

Model	HYA-WP-80W-TW3CCT	HYA-WP-120W-TW3CCT
Watt	80/60/40W	120/100/80W
Lumens	10400/7800/5850lm	15600/13000/10400lm
DLC#	S-K798U4	S-P5E8NQ
PF	>0.9	
Working Voltage	AC120-277V	
CCT	3000K/4000K/5000K Selectable	
Photocell	Pre-Installed	
Finish	Dark Bronze	
Efficiency	130LM/W	
CRI	Ra>80	
Operating Temperature	-40°F to 113°F	
Beam Angle	95°x105°	
Environment Location	IP65/ Wet Location	
PC/PACK	1	
Package Dim	15.35"x11.42"x9.25" / 390X290X235mm	
Package Weight	10.34LB/4.69KG	11.27LB/5.11KG

### Dimensions

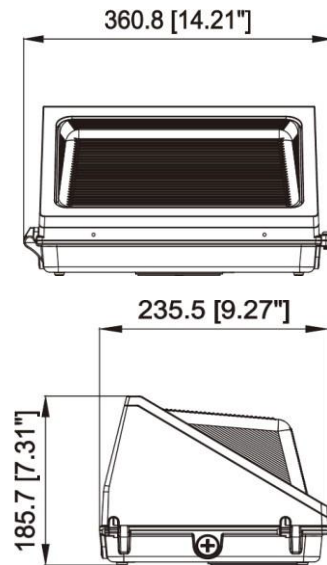

### Photometric Report

LUMINOUS INTENSITY DISTRIBUTION DIAGRAM

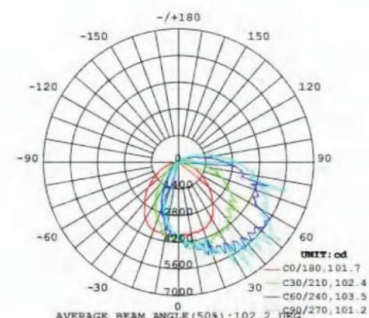

## LEDWall PackLight – WP Series WP2002

### Installation Instruction

1. Use a screw driver to unscrew the lamp screws and remove the upper half of the fixture.

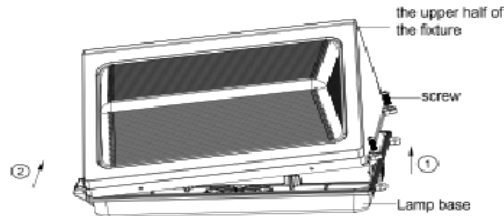

2. Unscrew the cover of the entry hole on the lamp base and remove the cover.



3. According to the embedded terminal box, punch the corresponding mounting hole on the light's mount.

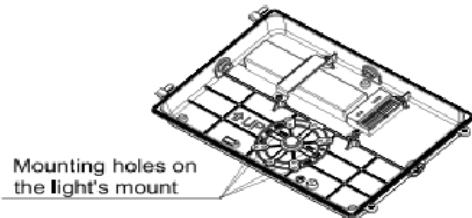

4. Put the input line in the embedded box passes through the waterproof pad and then passed through the lamp base.

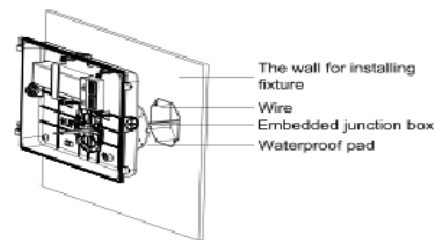

5. Use screw to lock the lamp base on the embedded junction box.

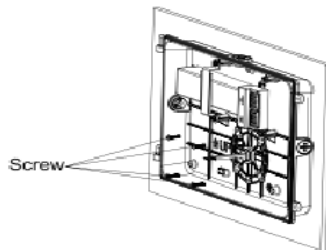

6. Connect the input wire and the dimming wire of the light, then put the connected wires into the embedded terminal box.

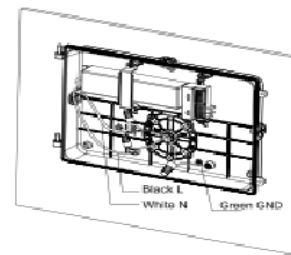

7. Connect the output wires of driver with the wires of PCB board.

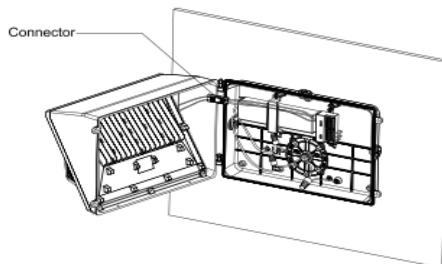

8. Use screws to lock the fixture. Installation completed.

